

- B 193**
- B 350**
- B 390**
- B 550**
- RB 400**
- BH 360**
- BH 550**
- BH 900**
- B 1025**
- B 120**
- BH1100**
- BH1300**
- BH1600**
- B 3200**
- B 4600**

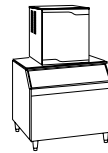

B 550 with MV 1000 +KBT 253 (sold separately)

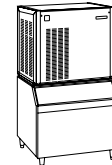

B 550 with MC 45 (sold separately)

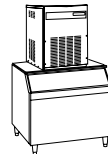

B 550+KBT1 with MF 51 (sold separately)

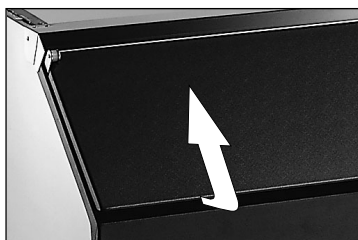
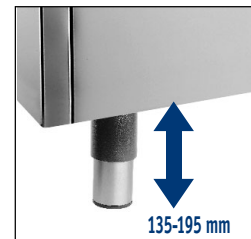

Ice Storage Bin



Cabine de Stockage

Eisspeicher

Cabina Almacenadora

Contentitore Ghiaccio

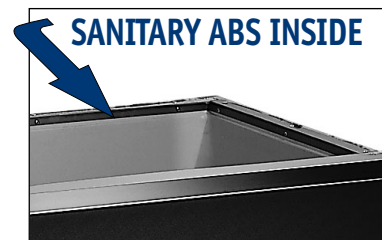

SANITARY ABS INSIDE

	CUBES Medium Gourmet			CUBES Full Dice			FLAKE ICE					
	[kg]	(lbs)	**N°	[kg]	(lbs)	**N°	[kg]	[lbs]	[WxDxH mm]	[WxDxH inches]	[mm]	[inches]
B 550 S	230	506	9800	230	506	15000	196	431	1075x785x1015	42 5/16"x30 14/16"x39 15/16"	135-195	5 5/16"-7 11/16"

Accessories:

- KBT 1 TOP insulated stainless steel top provides cover for B 550 and base when mounting a modular flaker
- KBE 75 EXTENSION KIT for increase storage capacity (+35 kg. - 75 lbs)
- KRB 550 - Caster kit

** Estimate

2

Years Warranty
Ans de Garantie
Jahre Garantie
Años de Garantía
Anni di Garanzia

Subject to certain limitations and exclusions
 Assujettie aux limites et exclusions prescrites
 Abhängig von Bestimmten Einschränkungen und Ausnahmen
 Sumitido a algunas limitaciones y exclusiones
 Soggetta ad alcune limitazioni ed esclusioni



This product qualifies for the following listings:

B 550

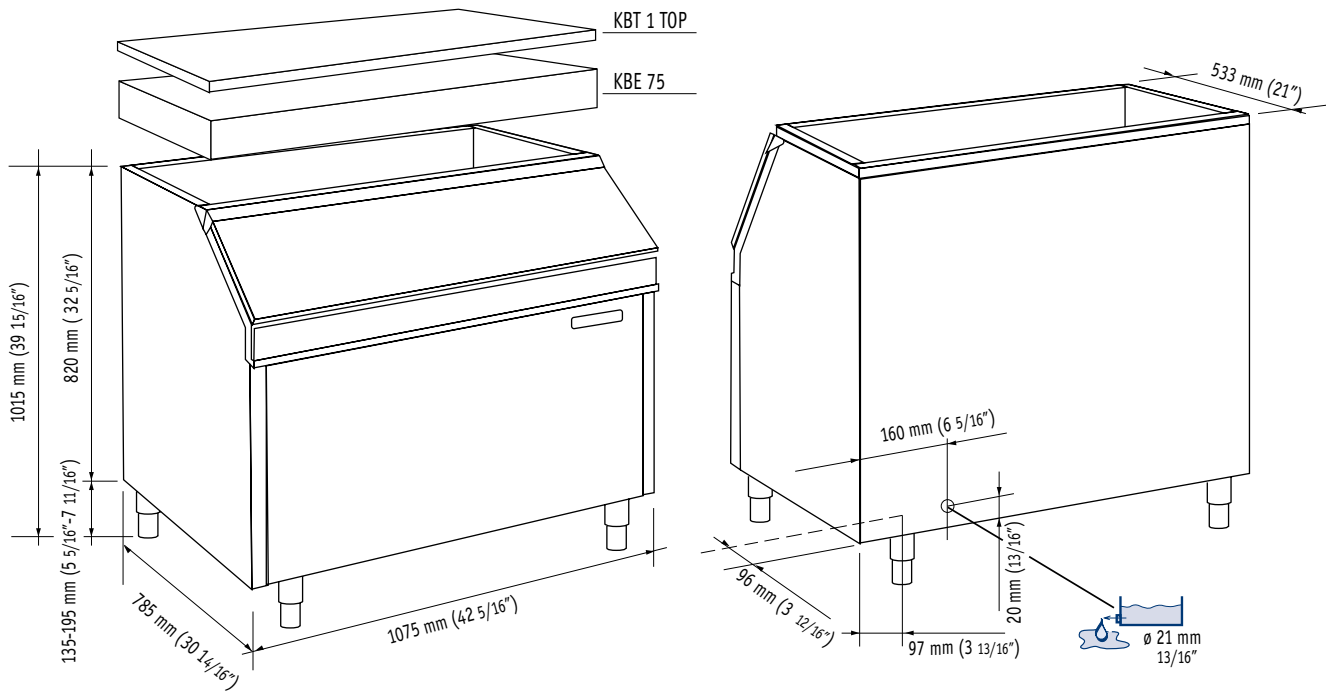

	[kg]	[lbs]		[kg]	[lbs]
B 550 S	55	121		63	139

The ideal bin for all modular ice machines, is particularly suited for the MC 15 and MC 45 and for the MF 41, MF 51, FME 804, FME 1204 and NME 654 modular machines. Its already large storing capacity of 487 litres may be increased by adding a KBE 75 extension (35 kg - 75 lbs). The liner is in sanitary ABS, mounted in one piece without corners and welding points. Polyurethane foam insulation of the cell. The plastic door allows easy access to the stored ice.

KBT 1 TOP

Insulated stainless steel top provides cover for bin B550 and base when mounting a modular flaker.

Cabine de stockage pour toutes les machines modulaires à glaçons, le modèle B 550 est particulièrement indiqué pour MC 15 et 45, ainsi que pour les machines modulaires MF 41, MF 51, FME 804, FME 1204 et NME 654. Sa grande capacité (487 litres) peut être accrue par une rehausse KBE 75 (35 kg). La bac intérieure de B 550 est sans angles ni soudures d'une seule pièce en ABS atoxique pour aliments. L'isolation de la cabine est assurée par du polyurethane expansé. La porte d'accès est en matériel synthétique et permet d'enlever aisément la glace.

COUVERCLE KBT 1

En tôle inox isolé, sert de couvercle pour la cabine B 550 et de plan d'appui pour les machines modulaire à glace en grains.

Dieser Speicher ist ideal für alle modularen Eisbereiter, besonders für die Typen MC15, MC45, MF41, FME804, FME1204 und NME654. Durch das Erweiterungselement KBE75 kann das bereits großzügige Speichervolumen von 487 Liter auf 522 Liter erhöht werden. Die Speicherzelle ist aus lebensmittelechten ABS in einem Stück gegossen. Die verwendete Isolierung ist aus Polyurethan-Schaum gefertigt. Die aus Kunststoff gefertigte Anthahmeklappe erleichtert die Eisentnahme.

ABDECKPLATTE KBT 1

Die als Zubehör erhältliche Abdeckplatte KBT1 dient als oberer Speicherabschluß und Aufstellfläche für modulare Flockeneisbereiter.

Contenedor ideal para los modelos modulares de cubitos, y particularmente para los MC 15 y MC 45. También se puede utilizar con los modelos MF 41, 51, FME 804, FME 1204 y NME 654. Su gran capacidad (487 lts.) puede ser aumentada añadiendo la extensión KBE 75 (35 kg.) La cuba de la B 550, sin ángulos ni soldaduras está construida de una única estampación en ABS atóxico alimentario. El aislamiento es a base de poliuretano expandido. La puerta, de material sintético permite una fácil recogida del hielo.

TAPA KBT 1

En acero inoxidable, rellena con aislamiento, sirve como cerramiento superior de la B 550, y de base cuando se monta un módulo de hielo triturado.

Contentore ideale per tutti i modulari a cubetti, è particolarmente adatto per l'MC 15 e MC 45 e per i modulari MF 41, MF 51, FME 804, FME 1204 e NME 654. La sua grande capacità (487 litri) può essere aumentata aggiungendo l'estensione KBE 75 (35 kg). La cella del B 550, senza angoli né saldature, è costituita da un unico stampo in ABS atossico per alimenti. La coibentazione della cella è in poliuretano espanso. Lo sportello, in materiale sintetico, permette un comodo prelievo del ghiaccio.

COPERCHIO KBT 1

In acciaio inossidabile protetto con isolamento, serve come coperchio per il B 550 e da base quando si monta un modulare granulare.



Scotsman[®]
Ice Systems

The one the world relies on.



USA, Canada, Latin America

Scotsman Ice Systems USA
775 Corporate Woods Parkway
Vernon Hills, IL 60061
Ph: (847) 215-4550
Fax: (847) 913-9844

customer.service@scotsman-ice.com

Europe

Scotsman Europe-Frimont S.p.A.
Via Puccini, 22
20010 Pogliano (Milano) Italy
Ph: (+39) 02-93960208
Fax: (+39) 02-93960201

scotsman.europe@frimont.it

Asia and Pacific

Scotsman Ice Systems-Frimont S.p.A. (R.O.)
627A Aljunied Road-#04-04 Biztech Centre
Singapore 389842
Ph: (+65) 6738 5393
Fax: (+65) 6738 1959

scotsice@singnet.com.sg

China

Scotsman Ice Systems
258 Tong Ren Road Golden Tower 7A
Shanghai-200040 Peoples's Republic of China
Ph: (+86) 21-62476056
Fax: (+86) 21-62476126

scotsmansh@online.sh.cn

Middle East & N. Africa

Scotsman Ice Systems Dubai Office
P.o. Box 13205 - Deira
Dubai - U.A.E.
Ph: +9716-5654036
Fax +9716-5654063

scotsman@emirates.net.ae

South Africa

Scotsman Ice Systems SA (PTY) Ltd.
10, Rhodes Street - Kensington B
P.o. Box 44 - Riverclub 2149
Ph: +27-11-7898400
Fax +27-11-7898411

scotsman@telkomsa.net